



Thermaltake View 270 TG ARGB Mid Tower Chassis

Datasheet

- **Style: Simple**
- **Size: Mid Tower supports up to E-ATX MB**
- **Material: Steel & Tempered Glass x 2**

Main Features

- **Connection** : Front I/O ports with 2 x USB 3.0 & 1 x USB 3.2 (Gen 2) Type C
- **Ventilation** : 1 preinstalled 140mm CT140 ARGB fan
- **Supports** : Supports AIO/DIY cooling solutions





Thermaltake View 270 TG ARGB Mid Tower Chassis

Specification

Model	View 270 TG ARGB	View 270 TG ARGB Snow	View 270 TG ARGB Matcha Green	View 270 TG ARGB Hydrangea Blue
P/N	CA-1Y7-00M1WN-00	CA-1Y7-00M6WN-00	CA-1Y7-00MEWN-00	CA-1Y7-00MFWN-00
Case Type	Mid Tower			
Chassis Dimension (H*W*D)	456 x 230 x 454 mm (18 x 9.1 x 17.9 inch)			
Net Weight	6.35 kg / 14 lbs.			
Panel	Tempered Glass x 2			
Color	Black	White	Matcha Green	Hydrangea Blue
Material	SPCC			
Cooling System	Rear(exhaust): 140 x 140 x 25 mm CT140 ARGB fan (1500rpm, 30.5 dBA) x 1			
Drive Bays	2 x 3.5", 1 x 2.5" or 2 x 2.5"			
Expansion Slots	7			
Motherboards	6.7" x 6.7" (Mini ITX), 9.6" x 9.6" (Micro ATX), 12" x 9.6" (ATX), 12" x 13" (E-ATX)			
I/O Port	USB 3.2 (Gen 2) Type-C x 1, USB 3.0 x 2, HD Audio x 1			
PSU	Standard PS2 PSU (optional)			
Fan Support	Top: 3 x 120mm, 2 x 120mm, 1 x 120mm 2 x 140mm, 1 x 140mm Right (M/B Side): 2 x 120mm, 1 x 120mm Rear: 1 x 120mm, 1 x 140mm Power Cover: 3 x 120mm, 2 x 120mm, 1 x 120mm			
Radiator Support	Top: 1 x 360mm, 1 x 240mm, 1 x 120mm Rear: 1 x 120mm			
Clearance	CPU cooler max height: 180mm VGA max length: 420mm PSU max length: 220mm			



Thermaltake View 270 TG ARGB Mid Tower Chassis

Packaging

Package Information	View 270 TG ARGB	View 270 TG ARGB Snow	View 270 TG ARGB Matcha Green	View 270 TG ARGB Hydrangea Blue
EAN Code	4711475643802	4711475643819	4711475643826	4711475643833
UPC Code	841163093818	841163093825	841163093832	841163093849
N.W	6.35 kg / 14 lbs.			
G.W	7.65 kg / 16.87 lbs.			
Carton Size (L x W x H)	525 x 290 x 510 mm / 20.67 x 11.42 x 20.08 inch			
Cuft	2.74			
Container	w/o pallet			
20'	380 pcs			
40'	780 pcs			
40' HQ	880 pcs			





Thermaltake View 270 TG ARGB Mid Tower Chassis

Appearance –
Black version



Angle view

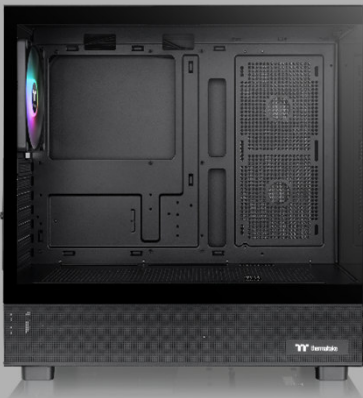

Left Side view



Front view



Right Side view



Internal Structure



Rear view



Top view



Bottom view



Thermaltake View 270 TG ARGB Mid Tower Chassis

Appearance –
Snow version



Angle view



Left Side view



Front view

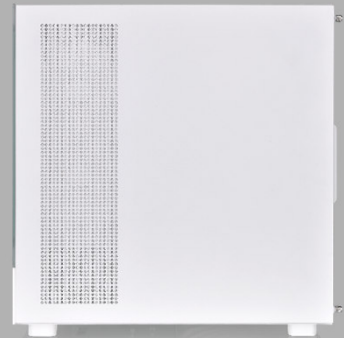

Right Side view

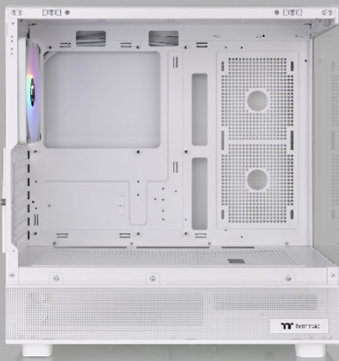

Internal Structure

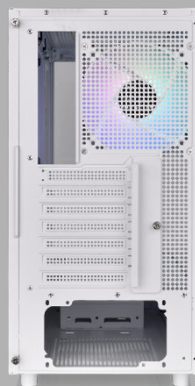

Rear view



Top view



Bottom view



Thermaltake View 270 TG ARGB Mid Tower Chassis

Appearance –
Matcha Green



Angle view



Left Side view



Front view

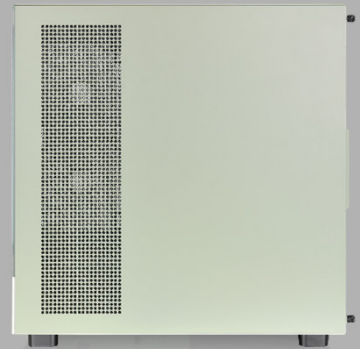

Right Side view



Internal Structure



Rear view



Top view



Bottom view



Thermaltake View 270 TG ARGB Mid Tower Chassis

Appearance –
Hydrangea Blue



Angle view



Left Side view



Front view

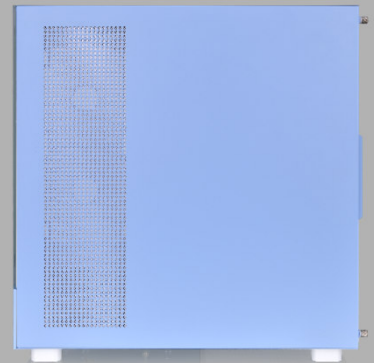

Right Side view

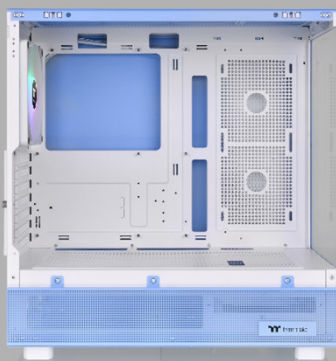

Internal Structure



Rear view



Top view



Bottom view



Thermaltake View 270 TG ARGB Mid Tower Chassis

Clearance



Maximum support up
to 120mm fan x 9



Maximum radiator support
up to 360mm on the top



Thermaltake View 270 TG ARGB Mid Tower Chassis

Structure (External)



USB 3.2 (Gen 2) Type-C x 1

USB 3.0 x 2

HD Audio



**4mm Front Tempered
Glass Window x 1**

**3mm Side Tempered
Glass Window x 1**



Thermaltake View 270 TG ARGB Mid Tower Chassis

Structure (Internal)

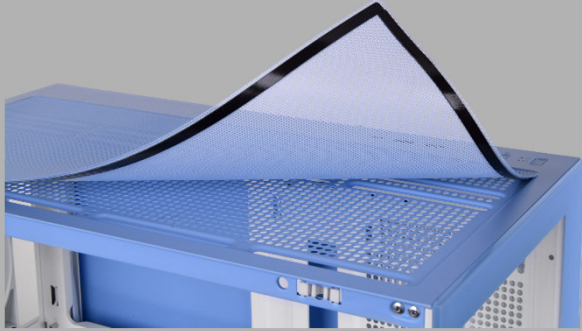

Top filter

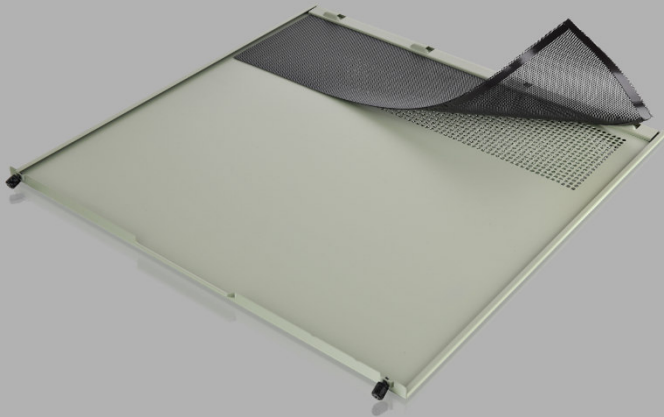

Right side filter



Bottom filter



Thermaltake View 270 TG ARGB Mid Tower Chassis

Structure (Internal)

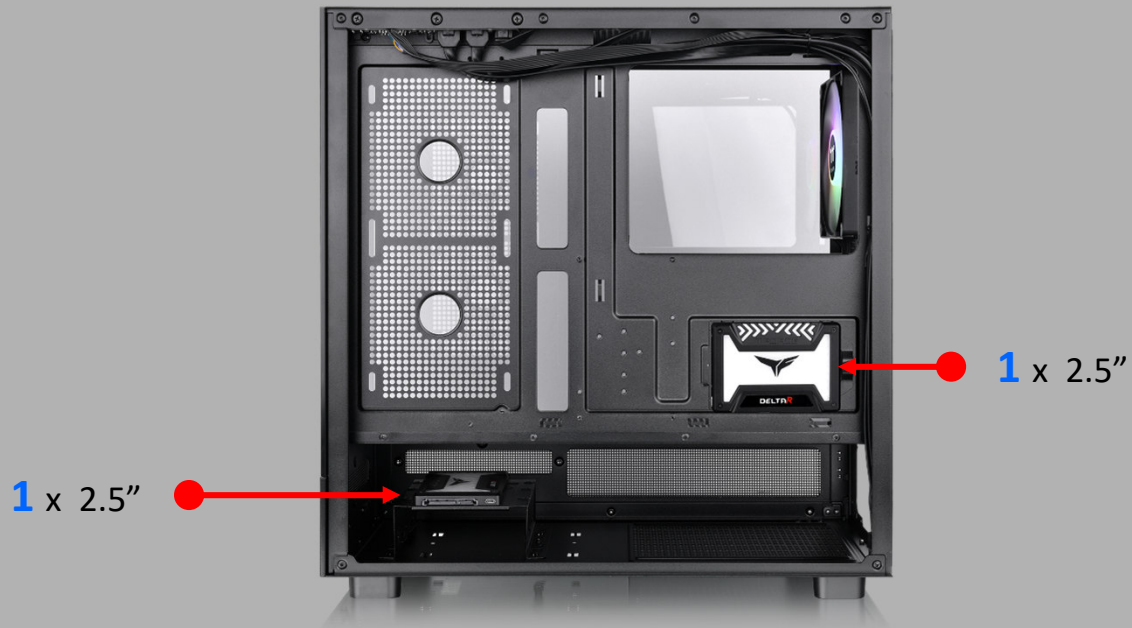

It can support up to 2 x 2.5" SSD



It can support up to 2 x 3.5" HDD



Thermaltake View 270 TG ARGB Mid Tower Chassis

Structure (Internal)



Full length power cover



3 x 120mm Fan on the power cover



Thermaltake View 270 TG ARGB Mid Tower Chassis

Pre-installed
CT Fans



Pre-installed one hydraulic bearing **CT140** fans which can effectively lower the operation noise and enhance the thermal efficiency.



Black/Matcha
Green Version



Snow/Hydrangea Blue Version

SPEC for Case ARGB **CT140 ARGB** fans

- Fan Speed: 500~1500 RPM
- Max. Fan Airflow: 77.37 CFM
- Max. Fan Air Pressure: 2.3 mm-H₂O
- Fan Noise Level: 30.5 dBA
- Fan Bearing: Hydraulic bearing



Thermaltake View 270 TG ARGB Mid Tower Chassis

Compatibility List

Fan Compatibility List			
	120mm	140mm	200mm
Top	3	2	-
Right(M/B Side)	2	-	-
Rear	1	1	-
Power Cover	3	-	-

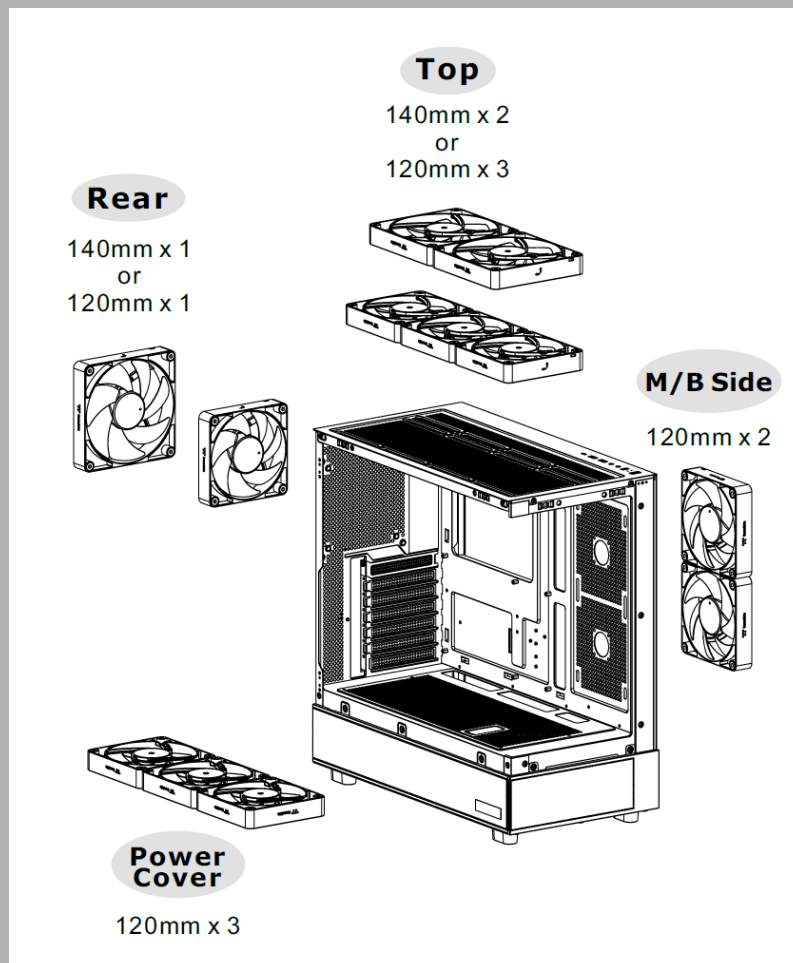



Thermaltake View 270 TG ARGB Mid Tower Chassis

All-in-One Compatibility

All-in-One Compatibility List						
	120mm	240mm	360mm	140mm	280mm	420mm
Top	●	●	●	-	-	-
Rear	●	-	-	-	-	-

